

- Lowers tooling costs
- Reduces setup time
- Produces bends over 90°
- Bends UHS steel
- Eliminates cam tooling to produce over bends
- Flexible and interchangeable
- Reduces down time
- Requires lower tonnage than traditional wipe tooling

Posi-Bend[™]
ROTARY BENDING SOLUTIONS

How Posi-Bend™ Rotary Benders Work

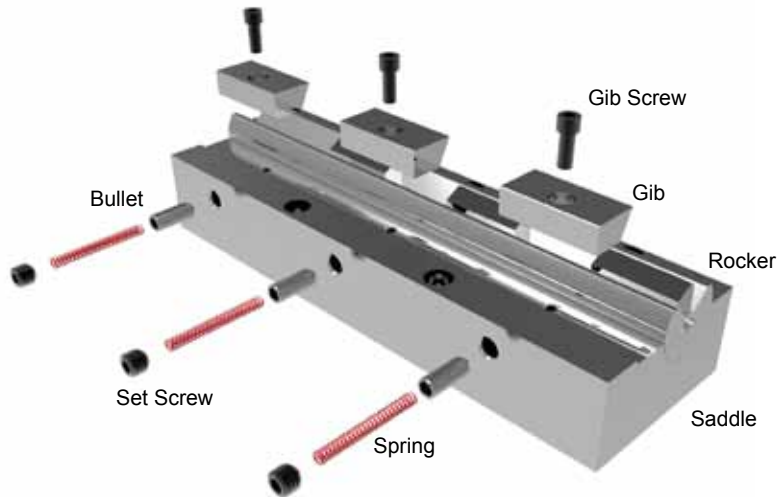

Start Position

Downward pressure of the press clamps the part with the rocker's bending lobes before the bending action starts.

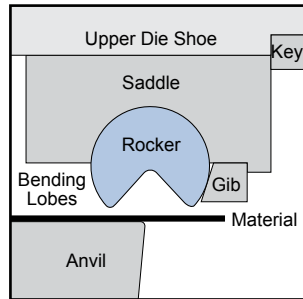

Bend

The rocker's rotation forms the material around the anvil with less pressure and material distortion/marring than wipe tooling.

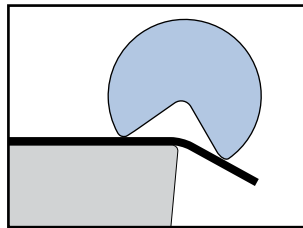

Overbend by 3°

The bending action continues to form the material around the anvil until desired angle is completed. The anvil should have 5° relief to allow for the 3° overbend. *(The 3° overbend applies to cold rolled steel only.)*

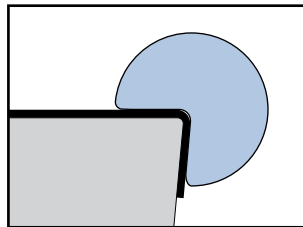

Material Springback

The rocker bends past 90° to compensate for material springback, leaving a 90° bent part ($\pm 1/2^\circ$).

An internal spring returns the rocker position without scraping the material like wipe tooling.

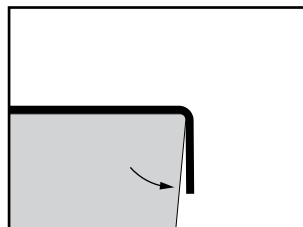

An Ideal Alternative to Wiping Dies

Easily-configured Posi-Bend™ Rotary Bender units are engineered to be less complex and less costly than wipe tooling. Rotary bending provides more consistent metal forming without wasting material on tests and regrinds.

The self-contained rotary bender gently rolls the material without unwanted distortion, sliding, or marring.

Features

- ◆ 87° rocker for 90° bends. This allows a 3° overbend for material spring back of cold rolled steel.
- ◆ Rockers and saddles are precision machined for interchangeability.

Bendable Materials

- ◆ Hot Rolled Steel
- ◆ Cold Rolled Steel
- ◆ Dual Phase Steel (DP590, DP780, DP980)
- ◆ High Strength Low Alloy Steel
- ◆ Advanced High Strength Steel
- ◆ Ultra High Strength Steel
- ◆ Stainless Steel
- ◆ Galvanized Steel
- ◆ Aluminum
- ◆ Pre-painted Aluminum
- ◆ Brass
- ◆ Copper
- ◆ And Much More!

Custom Orders

- ◆ Requests for custom orders can be made by completing a Special Request Quote Form (included in this catalog), contacting Customer Service, or online.
- ◆ Shorter lengths or segmenting are possible.
- ◆ Pressure pads can be ordered with Posi-Bend™ units.

Posi-Bend™ Rotary Benders are manufactured in the USA.

Bend Information

Channel Bend and Hat Bends – Paired Units

- ◆ Channel bends can be accomplished in one press stroke by pairing two benders face-to-face.
- ◆ In order to use standard benders, the spread or part channel must be greater than 2 times the (B) dimension.
- ◆ The rocker inside radius can be specially matched if required. Use a set of interlaced benders for a channel less than $2 \times B$.
- ◆ A pressure pad may be required to hold the part in place and to keep the material from crinkling at the bend radius.

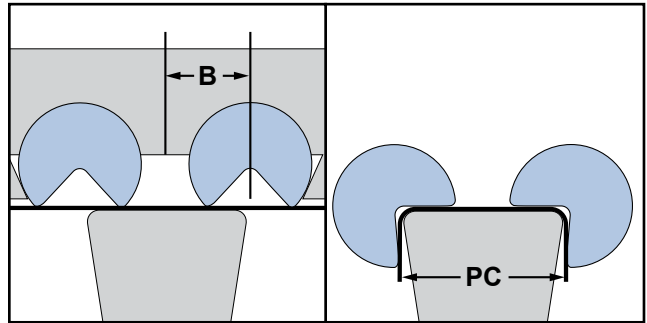

Channel Bend and Hat Bends

- ◆ For narrow channel and hat bends in one hit.
- ◆ Each unit has an integral pad.
- ◆ Hat bends can be handled with a two Zee Bend setup.

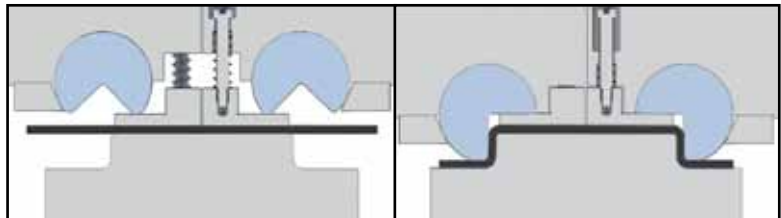

Interlaced Bends

- ◆ Custom interlacing to channel dimension.
- ◆ Forms a narrow channel in one hit.

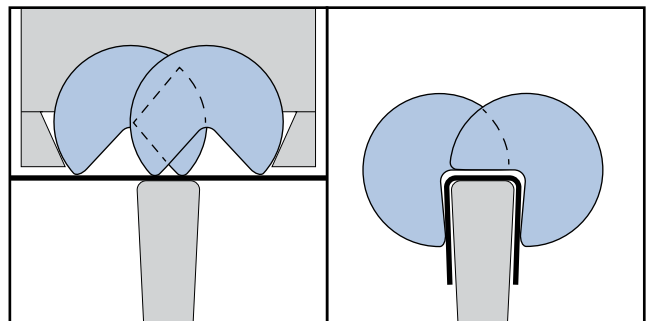

Large Radius

- ◆ A bend radius exceeding 3 times part thickness is considered a large radius bend.
- ◆ Large radius bends can be accomplished by using a larger size rocker.
- ◆ Adding a few extra degrees of over bend is required to compensate for material spring back.
- ◆ Under certain circumstances, the rocker's inside radius can be specifically matched to the part radius.

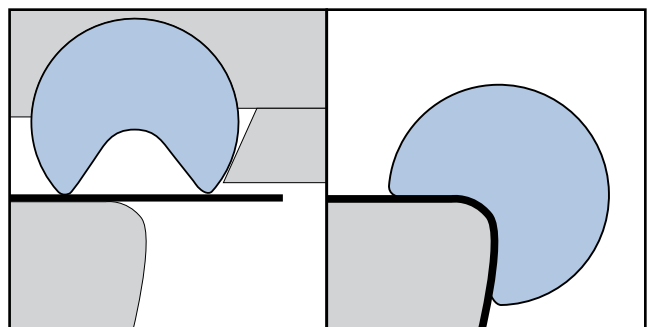

Bend Information

Short Leg

- ◆ Short leg bends require a recessed step in the bending lobe of the rocker to accommodate the shorter part height.
- ◆ Tonnage requirements will increase as compared to a standard bend.
- ◆ The formula to determine the shortest leg possible is:
 $2.6 \times (\text{part thickness}) + (\text{part radius})$.

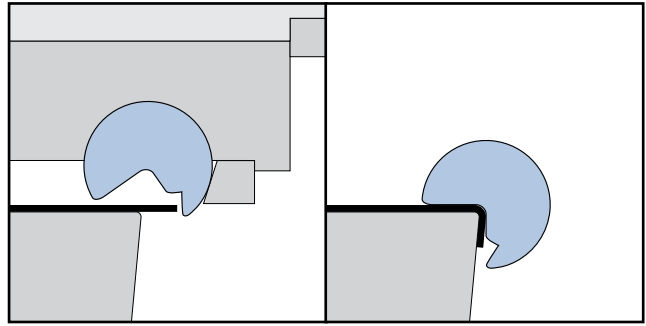

Over Square (up to 120°)

- ◆ Over square bends require a modification of the rocker angle while maintaining a constant bending lobe radius.
- ◆ The use of a pressure pad is suggested for over square bends over 110° to keep the rocker from sticking to the part.

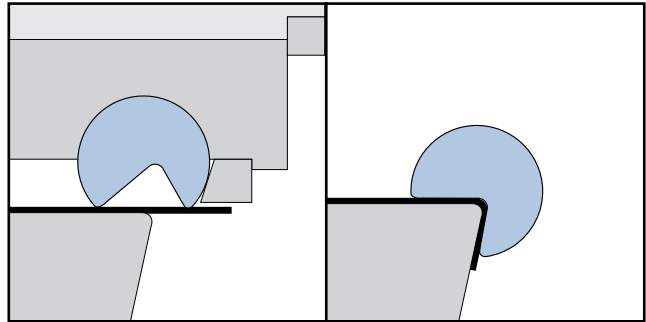

Under Square

- ◆ Part angle over 105°, bender centerline above part.
- ◆ Part angle up to 105°, bender centerline on part.

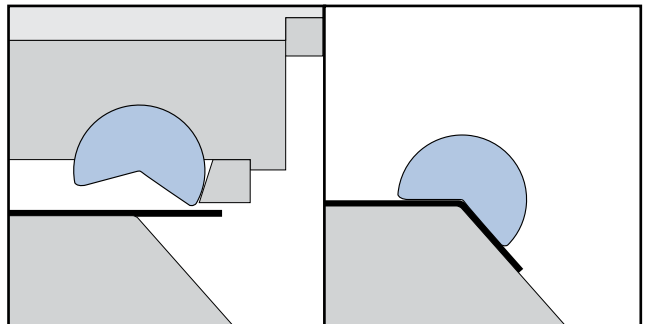

Zee Bend

- ◆ A true 90° rocker is used in Zee Bend applications.
- ◆ A pressure pad is usually required to make up the difference between the part height and the (I) dimension of the rocker.
- ◆ A slight modification to the bending lobe at the time of production of the bender may be required to obtain the desired part radius on the lower bend.

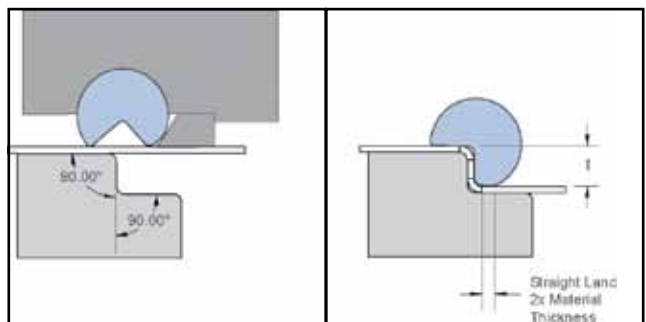

Design Information

Bender Location

- ◆ Use the formula for setting the “K” dimension for a 90° bend using a standard 87° rocker. Proper setting of the rocker centerline in relation to the anvil radius centerline is important for dimensioning the key slots needed to hold the backup key.

$$K = \frac{(PT + R)}{\tan (43.5^\circ)}$$

The “K” dimension for over bend or under bend applications is best determined by doing a CAD layout.

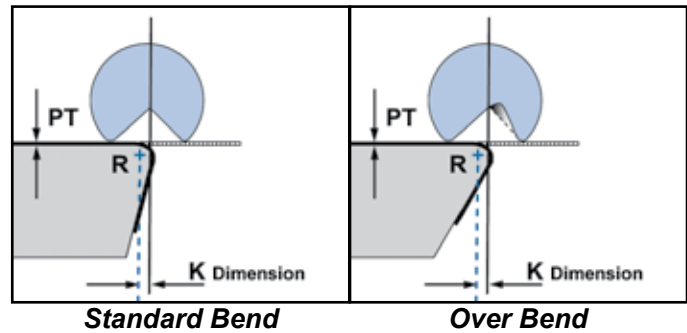

Force Formula for the Posi-Bend™

- F = Force Required (Pounds)
- YS = Yield Strength (psi)
- W = Width of Bend, inch
- PT = Part Thickness, inch
- G = Rocker Dimension, inch
- R = Part Radius (inside), inch

$$F = 2.25 \times \frac{YS \times W \times (PT)^2}{G + PT + R}$$

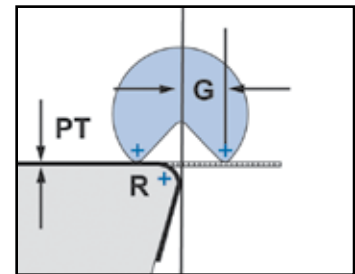

General Bend Allowance

The smooth rotary action of a bender requires a greater bend allowance than is typical with a coining or wipe bending operation. The formula for the bend allowance is:

$$BA = 0.01745 \times (180 - PA) \times [R + (PT \times .43)]$$

Important: Variances in material specifications and tolerances may require a change in the bend allowance when changing coils of the same material or changing material type altogether.

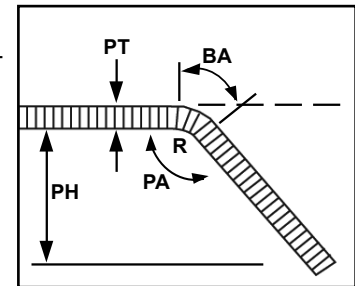

Pad Functions

- ◆ Eliminates contact marks on clamped surfaces.
- ◆ Protects cutout or hole from distortion.
- ◆ Matches preformed shape.
- ◆ Used for extreme overbend.
- ◆ Prevents humping of material when using an over sized bender.
- ◆ Used to match a standard rocker radius to Zee Bend dimension.
- ◆ Pad can usually be integral to the bender.

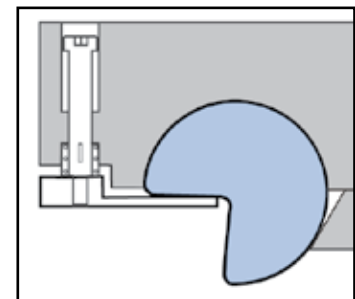

Dart Stiffener

- ◆ Dart Stiffeners are an easy way to add strength to any part and are formed using less tonnage with the rotary action of the Posi-Bend™.
- ◆ You can specify the size of the dart and a rocker with built-in dowel(s) will be made to fit your application.
- ◆ A relief in the anvil is necessary to accommodate each dart.

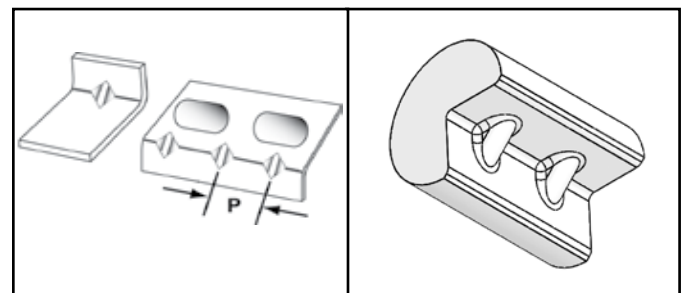

Ordering

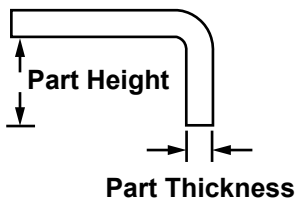
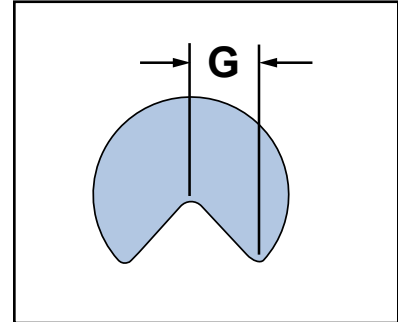
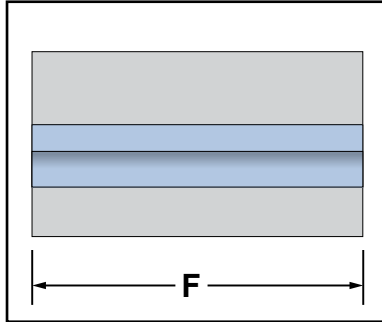
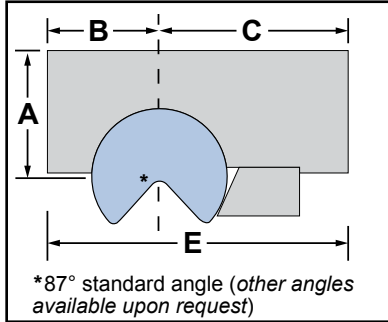

- Rocker HRC 52-58
- Saddle 4140 PH (Machineable)
- Saddle Socket coated for lubricity & wear resistance

How to Order

- ◆ Locate your material thickness in column 2 to determine appropriate rocker diameter.
- ◆ Select bender length (f) in last column. Other lengths available upon request.
- ◆ Confirm your part height in column 3

Model Number	Maximum Part Thickness	Minimum Part Height	Rocker Diameter	Saddle Height A	Front Saddle B	Saddle to Key C	Saddle Width E	G	Standard Lengths F	
									inch	mm
DLI-62-02	.010-.042 (0.25-1.0)	0.25 (6.35)	0.625 (15.88)	0.875 (22.23)	0.750 (19.05)	1.375 (34.93)	2.125 (53.98)	.246 (6.248)	2	50.1
DLI-62-04									4	101.6
DLI-62-06									6	152.4
DLI-62-08									8	203.2
DLI-62-12									12	304.8
DLI-62-24*									24	609.6
DLI-100-03	.043-.075 (1.0-1.9)	0.39 (9.9)	1.000 (25.4)	1.375 (34.93)	1.125 (28.58)	1.750 (44.45)	2.875 (73.03)	.393 (9.982)	3	76.2
DLI-100-06									6	152.4
DLI-100-09									9	228.6
DLI-100-12									12	304.8
DLI-100-24*									24	609.6
DLI-150-04	.076-.120 (1.9-3.0)	0.58 (14.8)	1.500 (38.1)	1.875 (47.63)	1.500 (93.10)	2.375 (60.33)	3.875 (98.42)	.590 (14.986)	4	101.6
DLI-150-08									8	203.2
DLI-150-12									12	304.8
DLI-150-24									24	609.6
DLI-150-36*									36	914.4
DLI-200-06	.121-.164 (3.0-4.1)	0.78 (19.7)	2.000 (50.8)	2.375 (60.33)	1.875 (47.63)	3.000 (76.20)	4.875 (123.83)	.786 (19.964)	6	152.4
DLI-200-12									12	304.8
DLI-200-24									24	609.6
DLI-200-36*									36	914.4
DLI-250-06									.165-.209 (4.1-5.3)	0.97 (24.6)
DLI-250-12	12	304.8								
DLI-250-24	24	609.6								
DLI-250-36*	36	914.4								
DLI-300-06	.210-.250 (5.3-6.4)	1.16 (29.5)	3.000 (76.2)	3.375 (88.90)	2.750 (69.85)	4.125 (104.78)	6.875 (174.63)	1.179 (29.947)		
DLI-300-12									12	304.8
DLI-300-24									24	609.6
DLI-300-36*									36	914.4

Measurements in inches. Millimeters shown in parentheses.

* Assembly consists of two rockers and one saddle.

Posi-Bend™ Special Request Quote Form

Date: _____

COMPANY INFORMATION

Company Name: _____
 Contact: _____ Title: _____
 Address: _____
 City: _____ State: _____ Zip: _____
 Phone: _____ Fax: _____
 E-mail Address: _____

APPLICATION INFORMATION

End use Method: Stamping Press Press Brake Preferred Product: Posi-Bend Accu-Bend

Order Quantity: _____ Material Type & Grade: _____

Material Tensile Strength: _____ Annual Production Volume: _____

L = Length of Bend (bender length): _____ PT = Part Material Thickness: _____

PH = Part Height (bent leg): _____ PR = Part Radius (inside): _____

PC = Part Channel (inside): _____ PA = Part Angle (inside): _____

Over Bend required (30° max): _____ Check here if tool marks are not acceptable

Check here if you are interested in test bending this part No. of drawings attached: _____

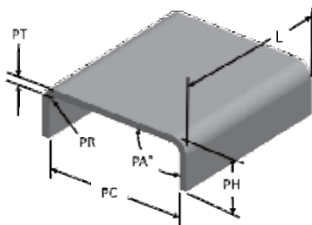

Customer
comments: _____

TYPE OF BEND (check one)

Square

Under Square

Over Square

"Z" Bend

Channel

"Hat" Bend

Short Leg

"J" Bend
(requires two hits)

Note: For "Z", "Hat" or "J" bends, please specify top of part to top of flange dimension in notes

- 1 Press Brake application may require special mounting plate to secure the Benders
- 2 Annual production volume will be assumed as 250,000, if it is not specified.
- 3 If the over bend angle is not specified by the customer, we will make a recommendation. However, this recommendation is not a guarantee and we make no warranty in final forming of material. We can perform a variety of test bending. Please contact our customer service regarding our test bending service.
- 4 Due to material characteristics we recommend the part radius should be at least equal to material thickness. The final part radius is a result of anvil geometry and material behavior.

Phone: 800-652-6462

Fax: 800-406-4410

Posi-Bend™ Installation

Installation and Adjustment

1. Do not remove gibs
2. Locate set screws at the back of the saddle. Remove using standard hex key (Fig. 1).
3. Rotate rocker slightly in clockwise/counter-clockwise motion to displace and free rocker rotation.
4. Keep springs and bullets within the saddle.
5. Position one piece of application material on landing of anvil and rocker holding face (Fig. 2).
6. Position a second piece of application material between the tangent of anvil radii and bender face of rocker. (Fig. 2)
7. The anvil should contain 2-3° extra clearance beyond the spring-back application requirement (Fig. 2).
Example material used: SAE1008-1010.
Typical spring-back: 3°
Application: 90° bend required (87° rocker used)
Anvil angle should be 5-6°.
8. Using positioning and reinforcement key, locate and adjust to the proper position and secure with mounting fasteners.
9. When producing long length bends, split into segmentations for greater adjustment.
10. Lubricate bender with 10-15wt. oil.
11. Return springs and tighten hex set screws.
12. Rotate rocker to ensure a proper assembly, free of debris.

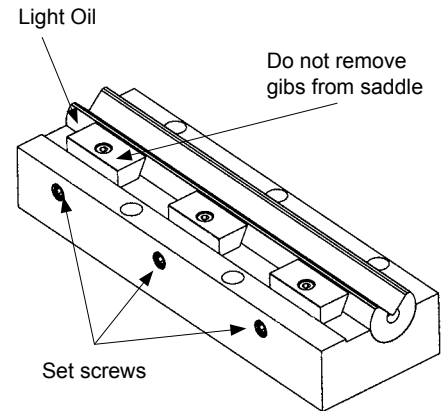

Figure 1

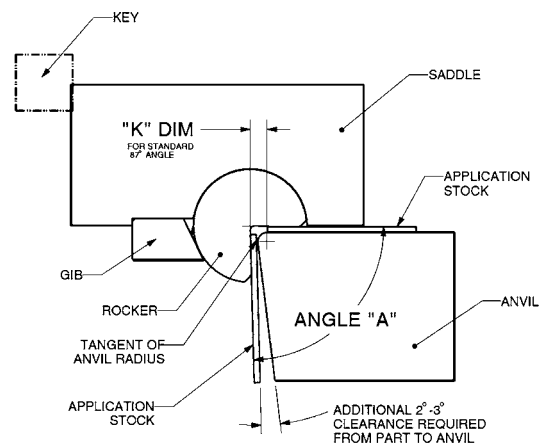

Figure 2

Preventative Maintenance

Remove and clean the saddle and rocker components within the first 50,000 cycles. Repeat the process every 100,000-200,000 cycles or as required. Increased cleaning may be necessary depending on your usage. Some materials (ex. galvanize) or excessively heavy oils may produce system degradation or may adversely affect rotation functionality.

During the cleaning process, apply a 10-15wt oil to ensure proper functionality.

Troubleshooting

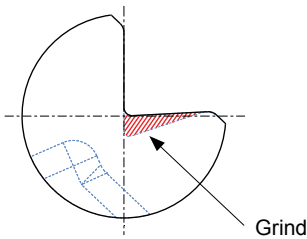

Figure 3

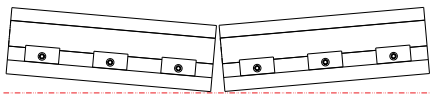

Figure 4

Toe in/out adjustment for long bend

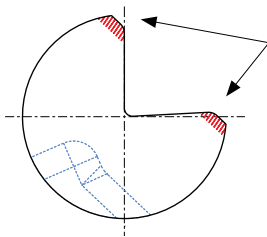
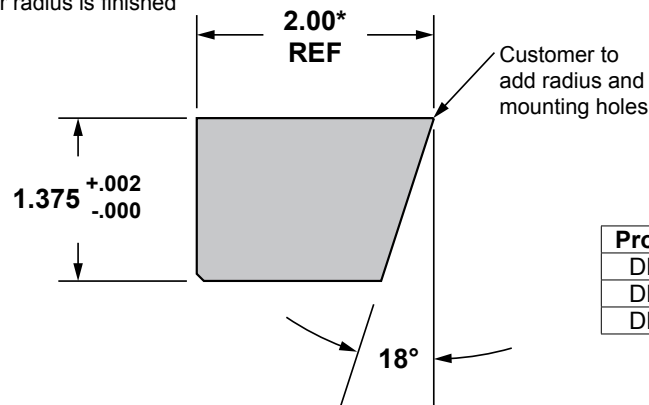

Figure 5

1. **Material under bend** – Bender set too far open or exceeds material thickness requirements. See setup instructions. Do not close the die set deeper.
2. **Material over bend** – Bender is set too tight or part radii is too small. See setup instructions. Do not coin.
3. **Material wrinkle near pinch point** – Anvil radii may be too small. Rocker diameter may be too large. Consult catalog and setup instructions.
4. **Excessive witness lines on material** – Bender is set too tight, application material yield strength is too high for rocker diameter, or there is insufficient clearance between anvil and rocker angle. Consult catalog and setup instructions.
5. **Coining or imprinting marks on part** – Bender is set excessively deep. See setup instructions. For additional over-bending, grind bending face slightly. See (Fig. 3).
6. **Bend on ends vs. center have tighter radii** – In long bend applications, the ends of material are less restrictive and forces are lower. Segmented benders in smaller lengths will provide increased adjustability. This is known as adjusting the toe-in or out. See (Fig. 4). See setup instructions.
7. **Rocker sticks during operation** – Debris or excessive buildup appears between rocker and saddle. Springs or bullets may need to be replaced. See preventative maintenance.
8. **Working with painted or sensitive surfaces** – If coining or imprint marks occur, polishing the material contact lobes (Fig. 5) will greatly reduce to eliminate any imperfections. See note #5 above for additional troubleshooting.

Additional Accessories – Bending Anvil

*Final length to be determined by customer after radius is finished



Product Code	Length
DLI-12-ANV	12.000
DLI-24-ANV	24.000
DLI-36-ANV	36.000

Commitment to Quality & Customer Satisfaction

Dayton Lamina is a leading manufacturer of tool, die and mold components for the metal-working and plastics industries. As a customer-focused, world-class supplier of choice, we provide the brands, product breadth, distribution network and technical support for all your metal forming needs.

Our goal is to give our customers the most innovative and value-added products and services.



DAYTON Lamina™

a MISUMI Group Company



Lamina® LEMPCO

*Dayton Lamina's line of Danly products is available only to North America.

www.daytonlamina.com